

MODEL 700
 BOARD 1 Rev 1
 SEQUENTIAL CIRCUITS
 113179

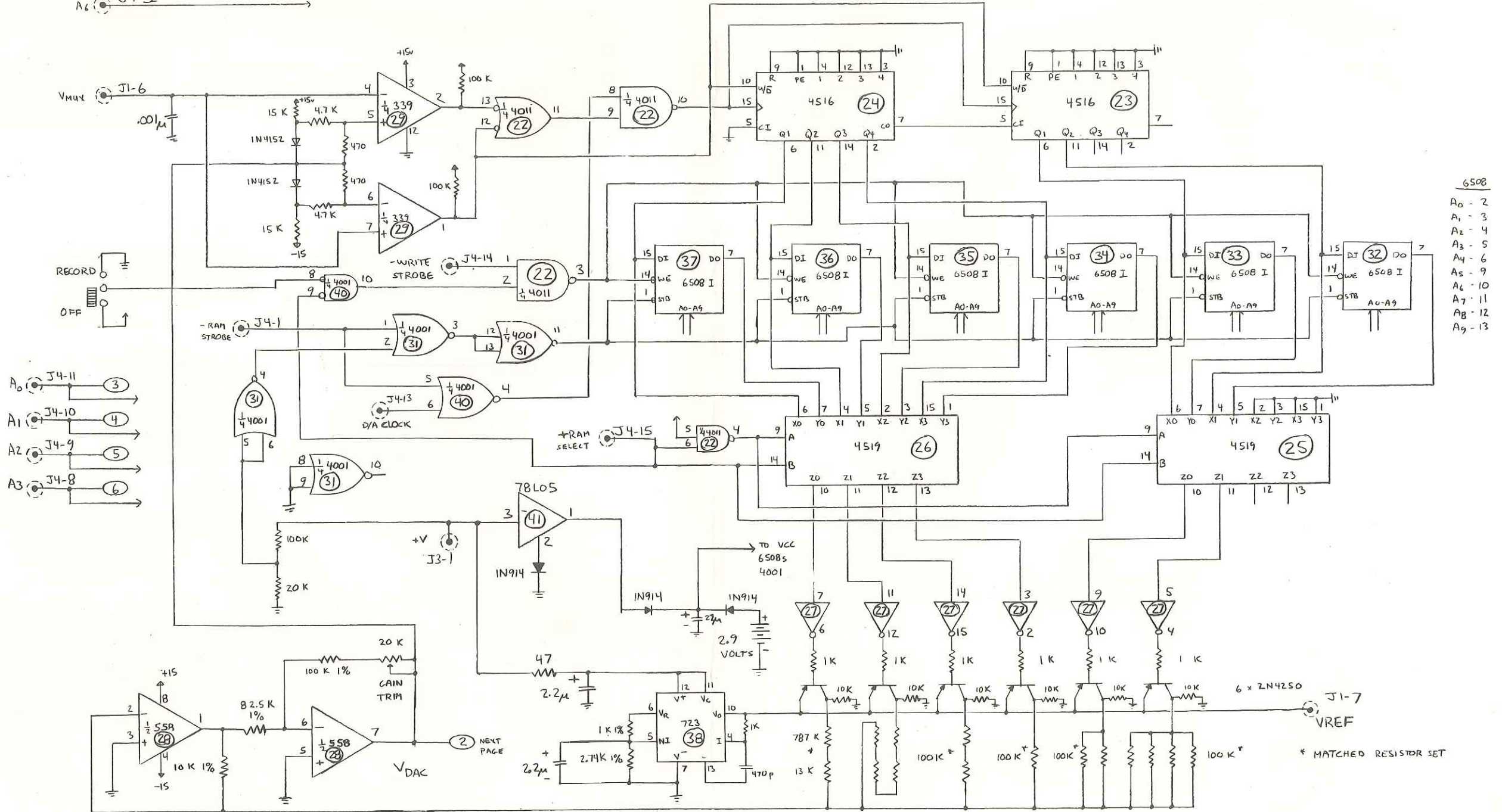

- 6508
 A0 - 2
 A1 - 3
 A2 - 4
 A3 - 5
 A4 - 6
 A5 - 9
 A6 - 10
 A7 - 11
 A8 - 12
 A9 - 13

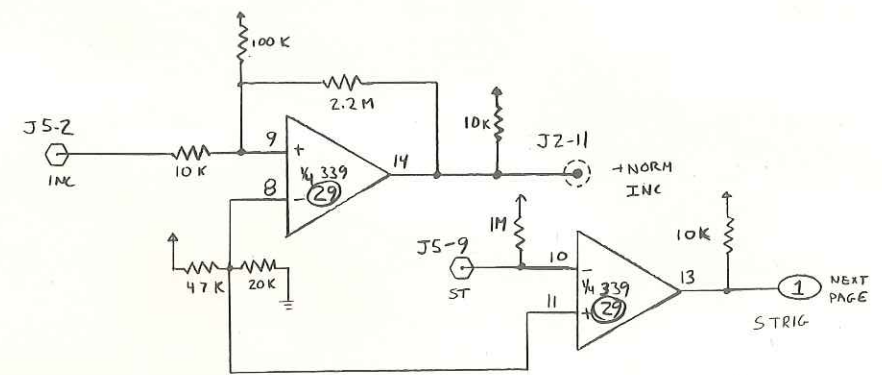
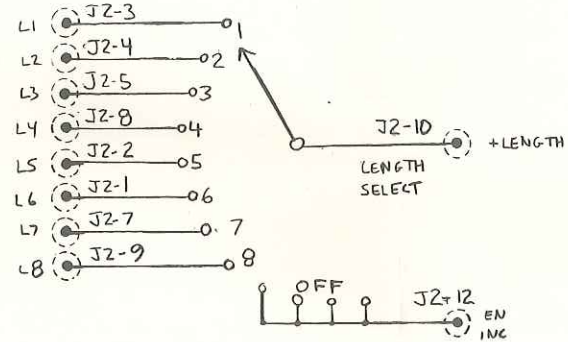
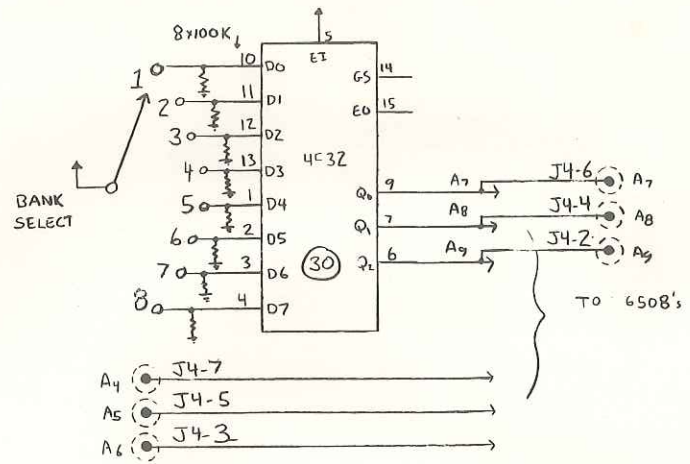
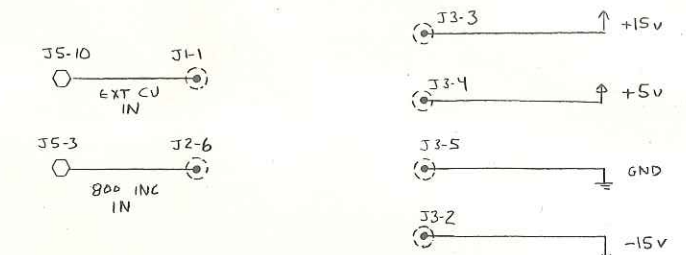
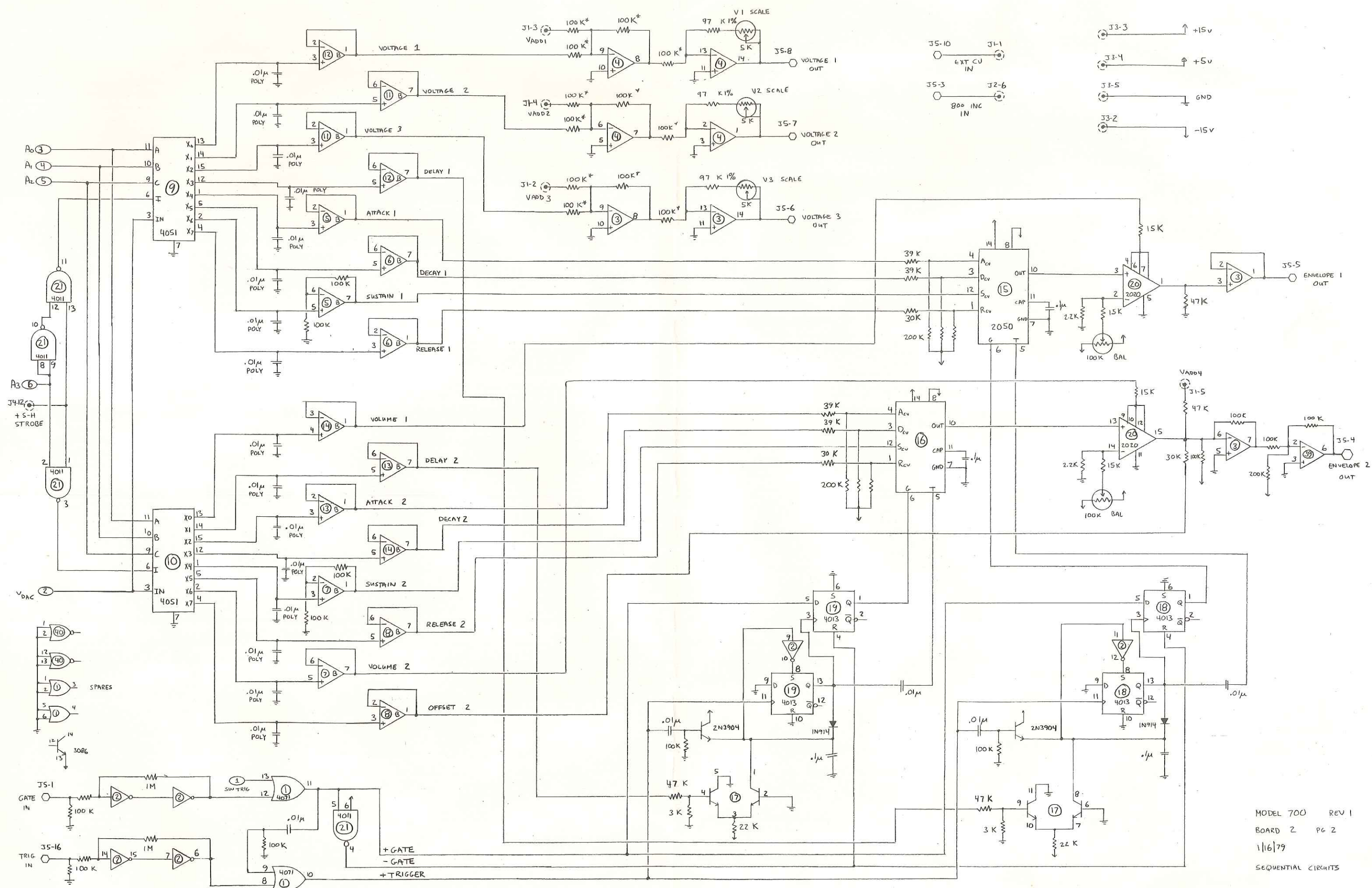

MODEL 700 REV 1
 BOARD 2 PG 2
 1/16/79
 SEQUENTIAL CIRCUITS

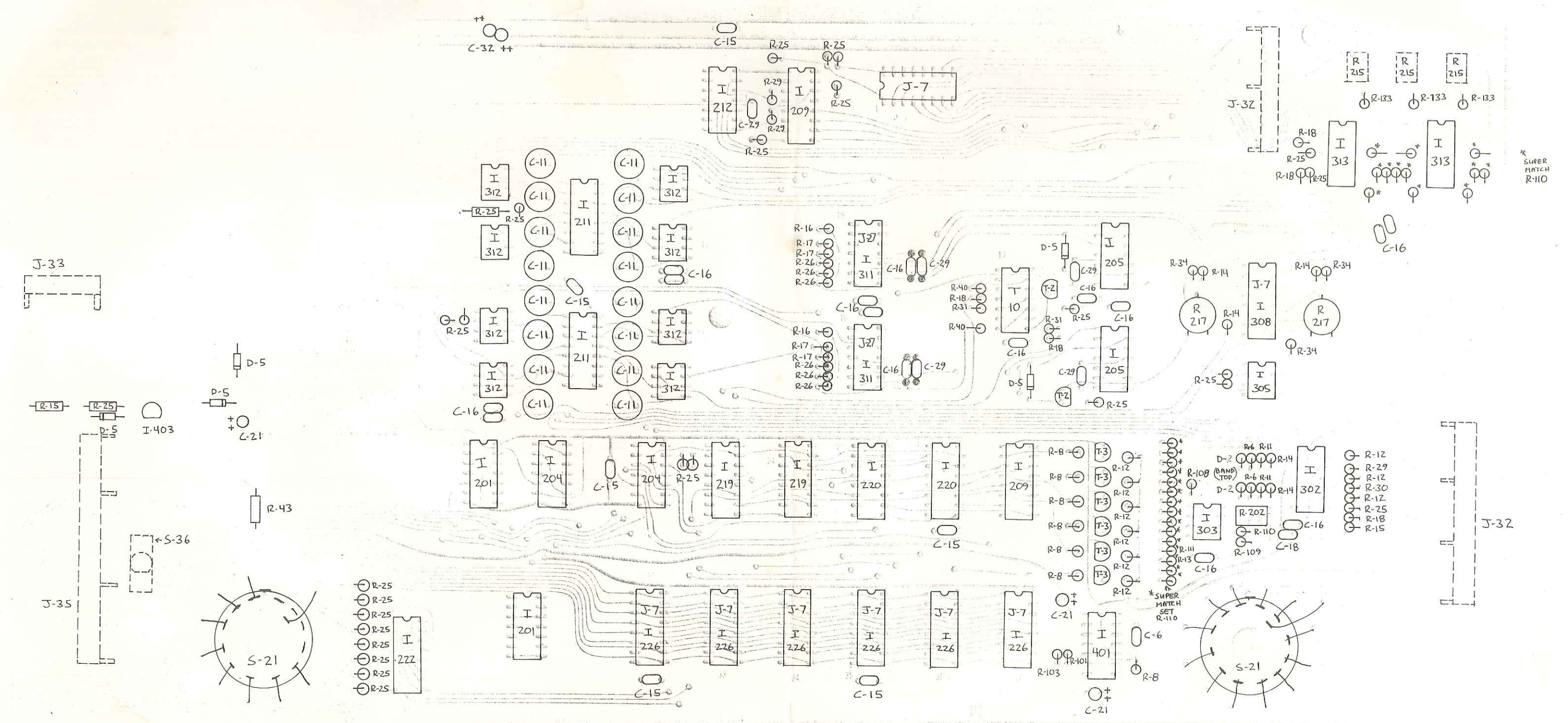

BEND TABS ON S-21
AS MUCH AS POSSIBLE.
CUT UNUSED TABS OFF.

BEND TABS ON S-21
AS MUCH AS POSSIBLE.

BOARD 2

MODEL 700
Doc. No. PP112

REV 1.0

1/29/79

UNLESS OTHERWISE SPECIFIED DIMENSIONS ARE IN INCHES TOLERANCES ARE: FRACTIONS DECIMALS ANOLES MATERIAL		J H G F E D C B A		SEQUENTIAL CIRCUITS INC	
FINISH		DATE		TITLE BOARD 2 - ASS'Y DIAGRAM	
1/29/79		1/29/79		MODEL No. 700	
001 104		I.O		DOCUMENT No. PP112	
FIRST LAST S/N		DATE		REVISION	
SCALE 2:1		DATE		ISS	
				SHEET 1 OF 1	

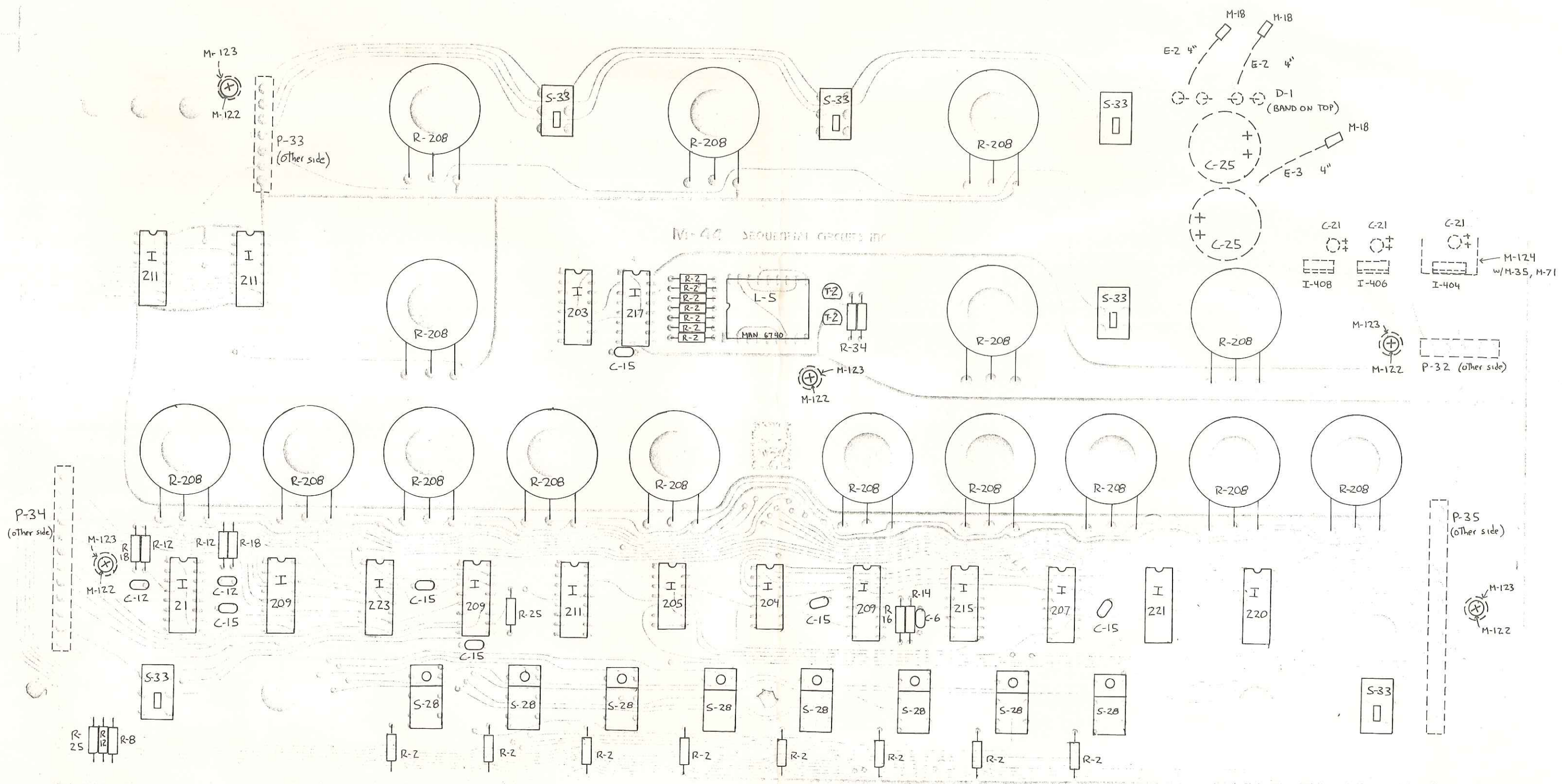

BOARD 1

MODEL 700

REV 1

1/29/79

UNLESS OTHERWISE SPECIFIED DIMENSIONS ARE IN INCHES TOLERANCES ARE: FRACTIONS DECIMALS ANGLES XX 1/2		J H G F E D C B A ISS		SEQUENTIAL CIRCUITS INC	
MATERIAL		TITLE		BOARD 1 - ASS'Y DIAGRAM	
FINISH		DATE		MODEL NO. 700	
105		1/29/79		DWG NO. PP111	
001/04		O.O		APP	
SCALE 2:1		DATE		REVISION	
FIRST LAST 3/N		DATE		REVISION	